

PEDIATRIC / NEONATAL CUSTOMIZED EXTENDED CONNECT[®] TRACHEOSTOMY TUBE TEMPLATE

ARCADIA MEDICAL[®]

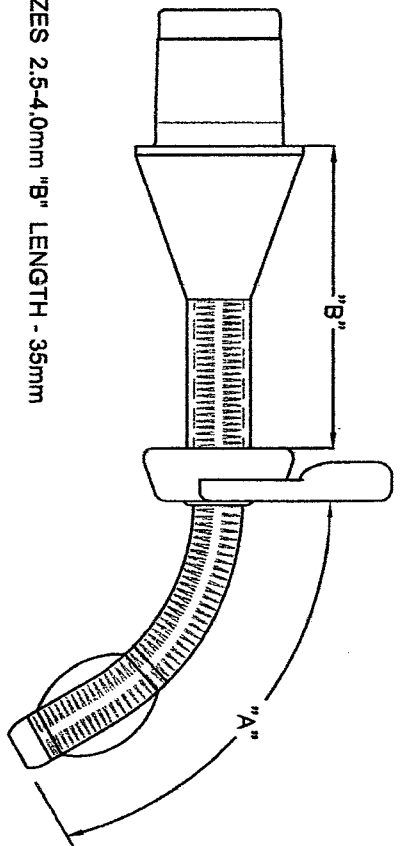

FOR SIZES 2.5-4.0mm "B" LENGTH - 35mm
FOR SIZES 4.5-5.5mm "B" LENGTH - 40mm
LENGTH "B" OTHER THAN ABOVE SPECIFY

WIRE REINFORCED AIRWAY

SIZES AVAILABLE 2.5-5.5,
*6.0-6.5, 7.0 mm

I.D. _____ mm

LENGTH AT
CENTER LINE "A" _____ mm
LENGTH AT
CENTER LINE "B" _____ mm

CLINICIAN NAME:

SIGNATURE: _____ DATE: _____

CLINICIAN CREDENTIALS:

PATIENT/CUSTOMER ID:

SPECIAL ORDERS WILL BE
HANDLED ON AN INDIVIDUAL BASIS

COMMENTS:

SHIP TO:

DISTRIBUTOR NAME:

COUNTRY:

QUANTITY ORDERED _____ UNIT(S)

ARCADIA APPROVAL:

CUSTOMER P.O. NUMBER:

REORDER NUMBER:

AMEXC-

CUFF OPTIONS

CTS CLOSE TO SHAFT CUFF

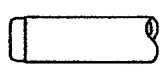

CUFFLESS

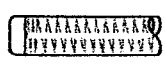

NECK FLANGE OPTIONS

"V" NECK FLANGE

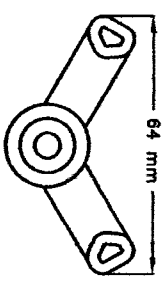

PED/NEO SIZES 2.5-5.5mm

LARGE PERFECT FIT
NECK FLANGE

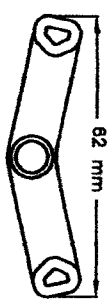

PED/NEO SIZES 2.5-5.5mm

SMALL PERFECT FIT
NECK FLANGE

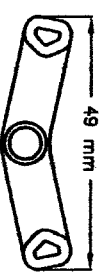

NEONATAL SIZES 2.5-4.0mm

STANDARD ADULT NECK FLANGE

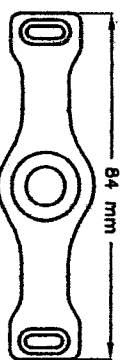

*ADULT SIZES ONLY 5.0, 5.5, 6.0, 6.5, 7.0mm

Bryan Medical, Inc.

Fax: 513-272-1610

bryanmedicalinc@fuse.net

Ph: 513-272-1600

www.bryanmedical.net

AMEXC FORM 30 REVISION F

NON STERILE PRODUCT: MUST BE STEAM STERILIZED PRIOR TO USE.
CAUTION: FEDERAL (USA) LAW RESTRICTS THIS DEVICE TO SALE BY OR ON THE ORDER OF A PHYSICIAN.
NOTE: ANY REQUIRED MODIFICATIONS WILL BE MADE WITH THE APPROVAL OF THE CLINICIAN.
PLEASE PRINT CLEARLY. ARCADIA MEDICAL WILL REVIEW THE FINISHED TEMPLATE FOR CONSENT.